

Aluplast - Ideal 7000 - drzwi wejściowe

Dzwi jednoskrzydłowe otwierane do wewnątrz.

170 002 - Ościeżnica 70mm Ideal 7000

269 060 - Próg aluminiowo-tworzywowowy 20x85mm Aluplast

170 033 - Skrzydło drzwi 116mm otw do wewn

120 649 - Listwa przyszybowa Soft-line

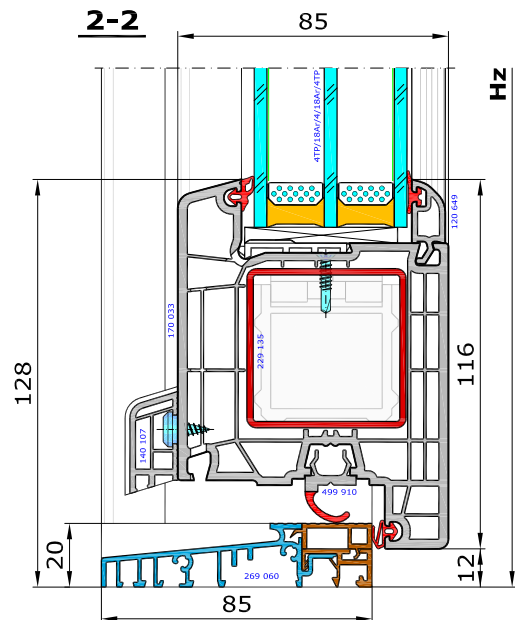
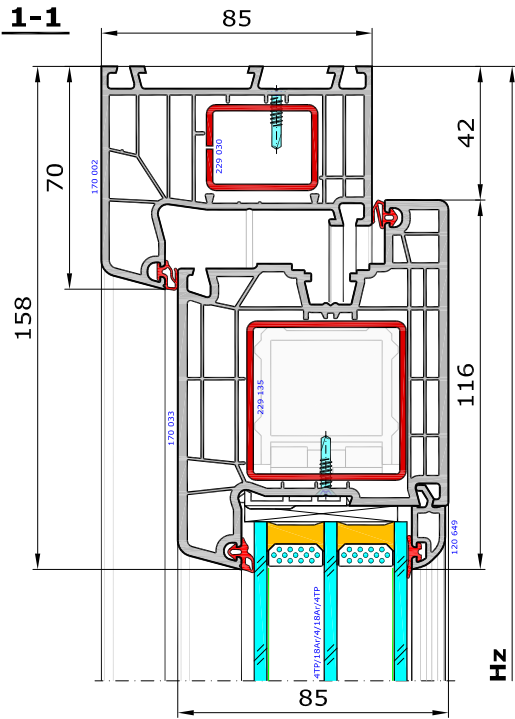

Schemat - lewy

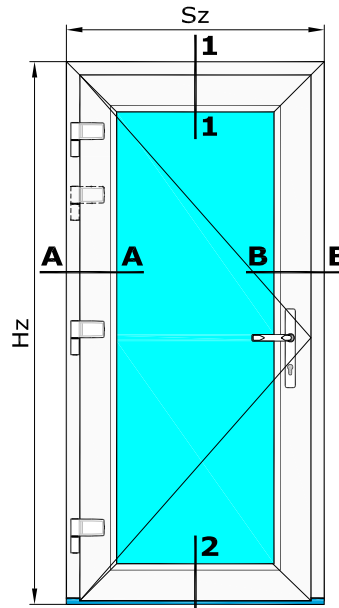

Schemat - prawy

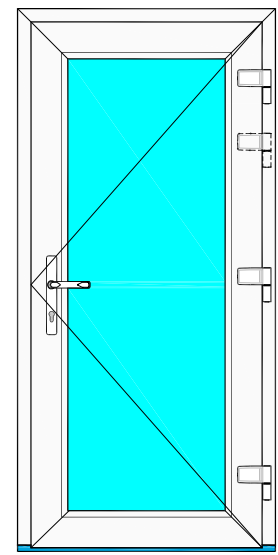

2 Widok drzwi od wnętrza pomieszczenia

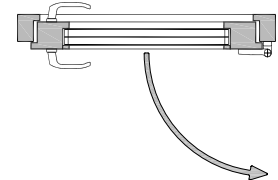
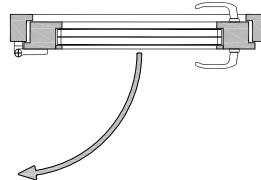

A-A

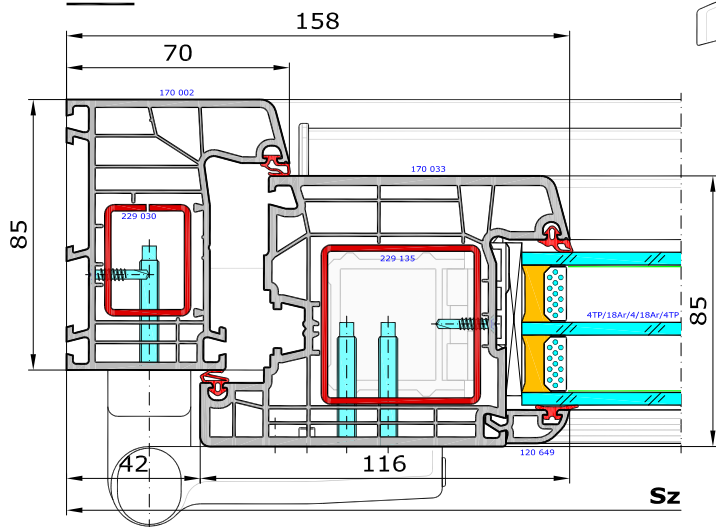

B-B

