

HS 68 schemat A

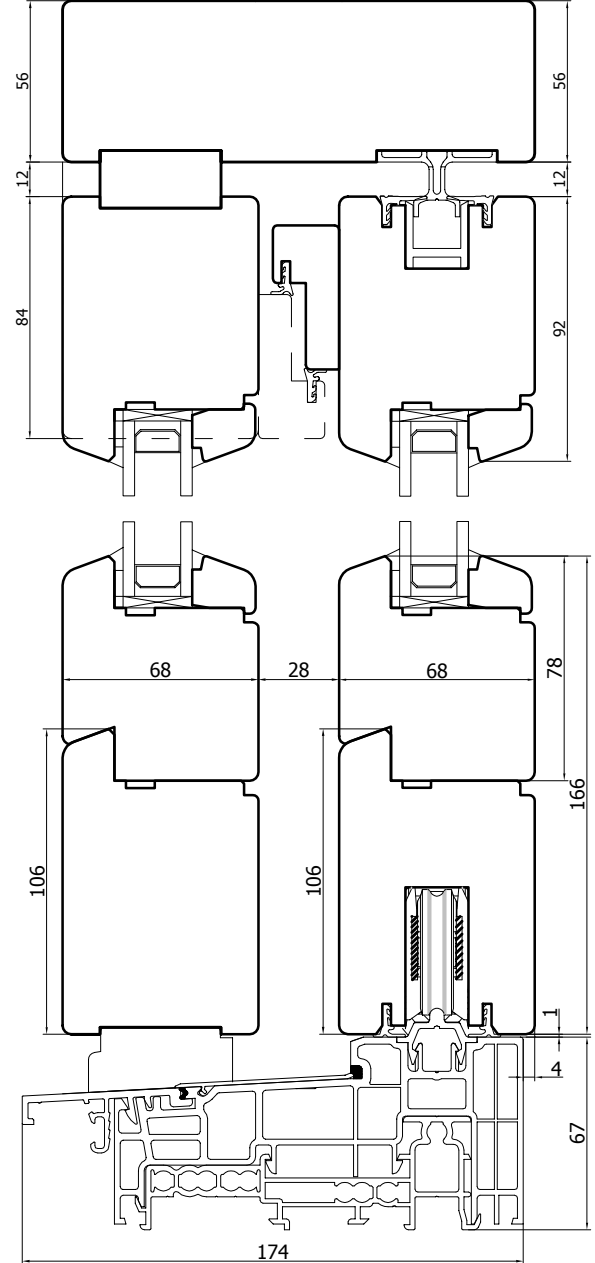

PRÓG HS G-U THERMOSTEP

HS 68 schemat D

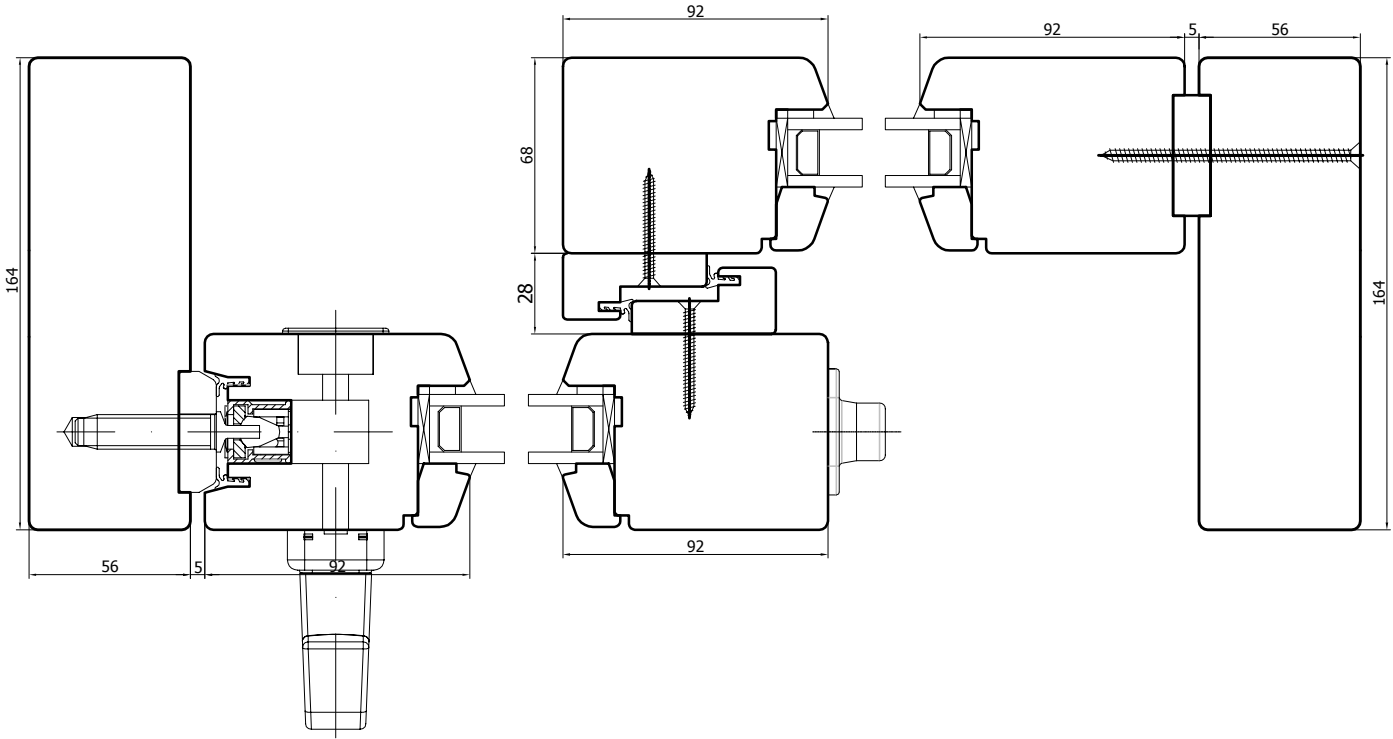
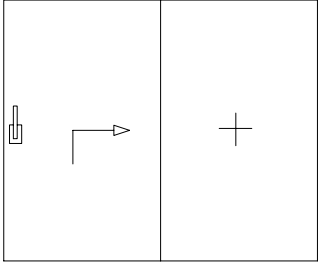
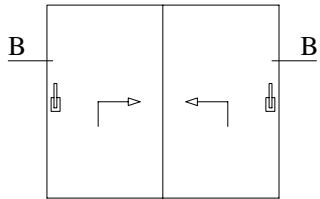
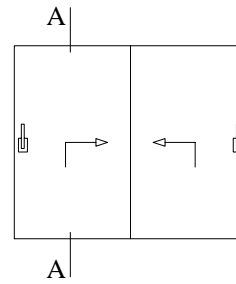

B-B

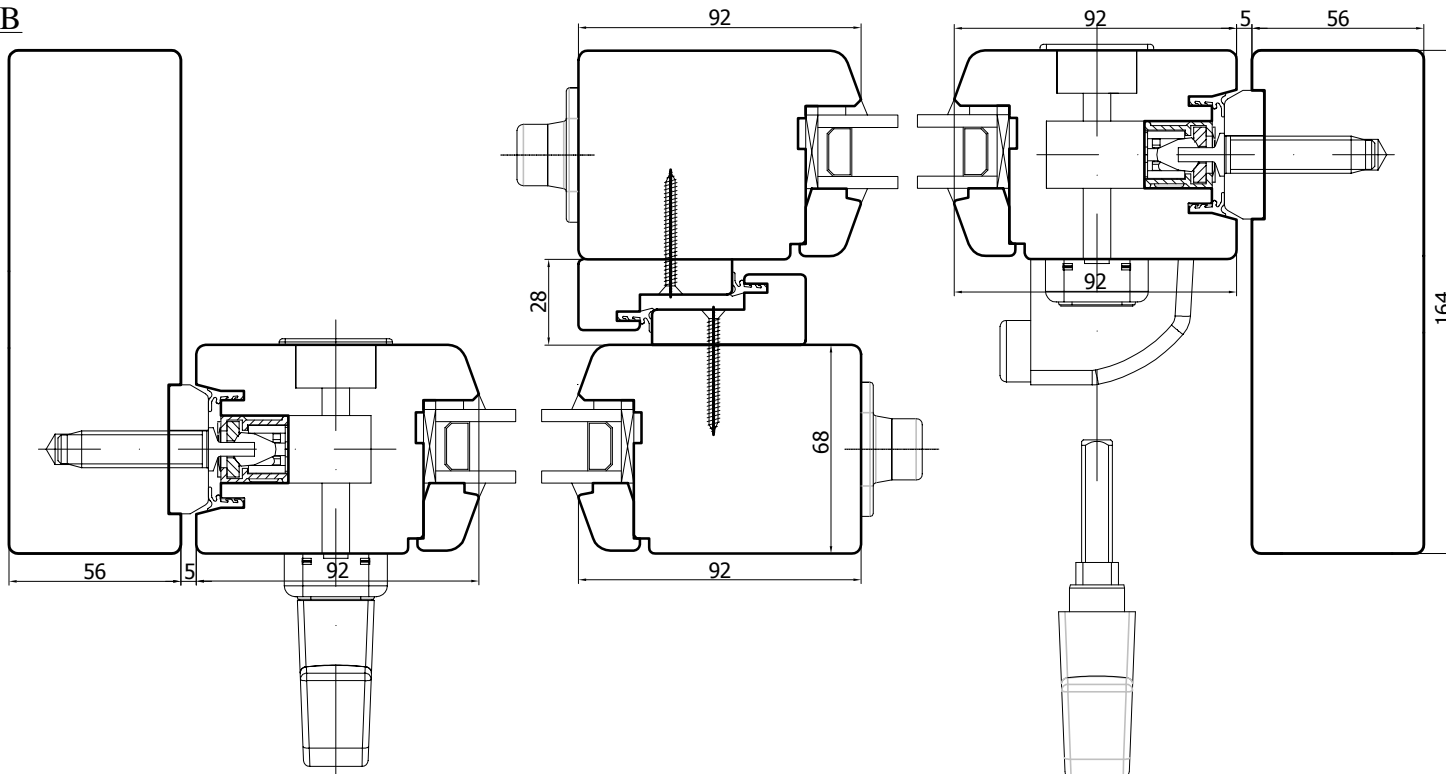

A-A

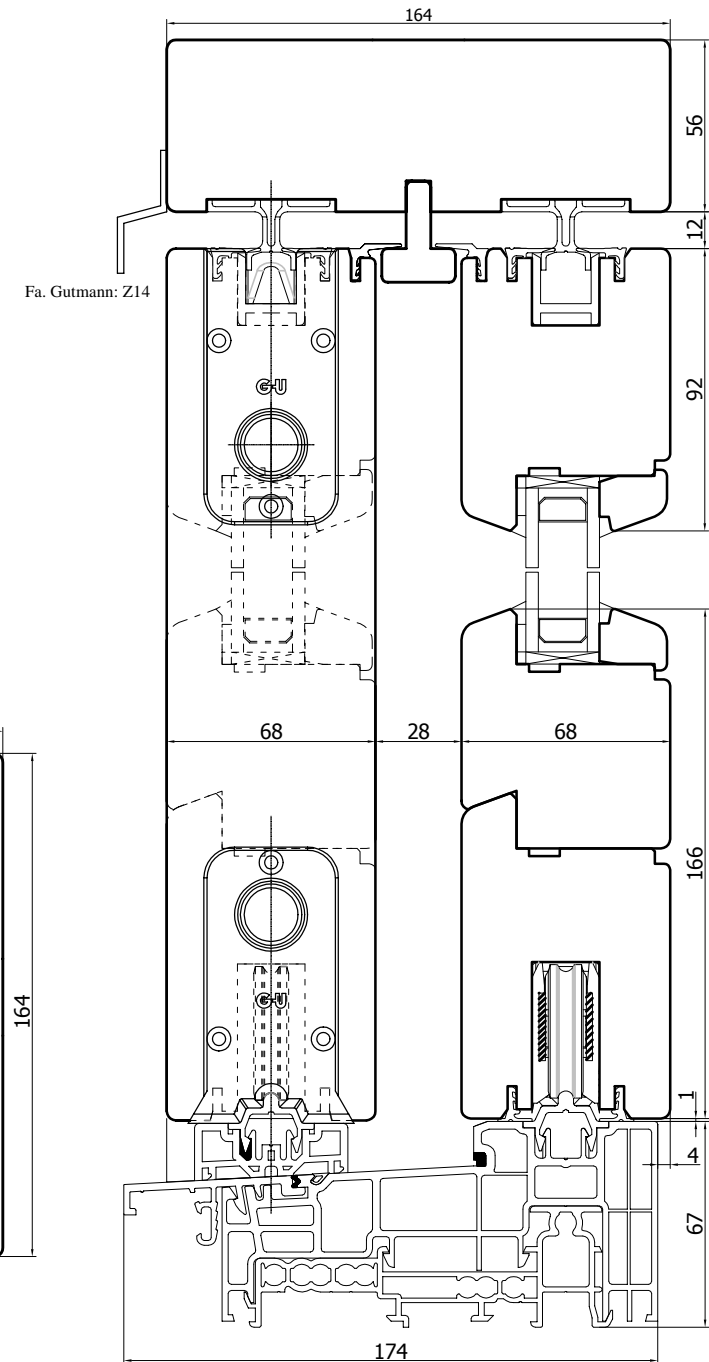

PRÓG HS G-U THERMOSTEP

Drzwi podnosząco - przesuwne HST

Schematy HST do wykonania

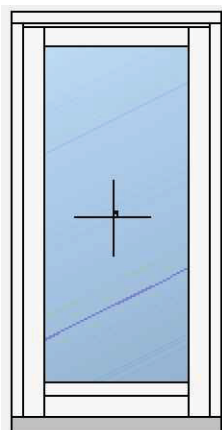

HST FIX

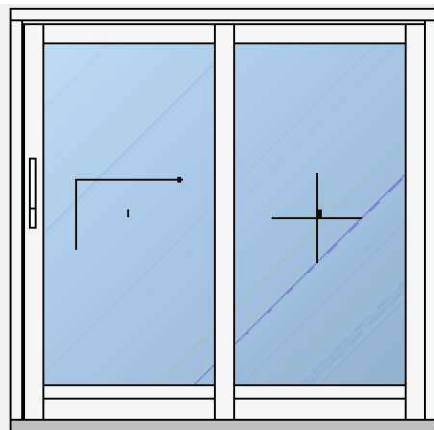

Schemat A (2 kw.) otw. na prawo

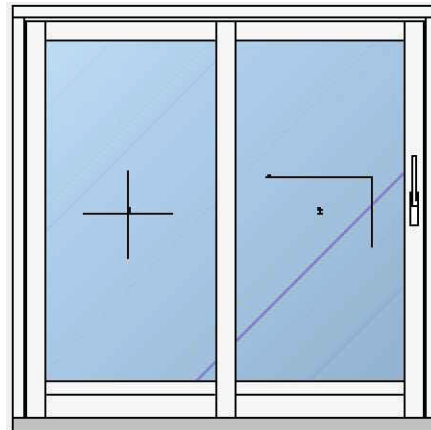

Schemat A (2 kw.) otw. na lewo

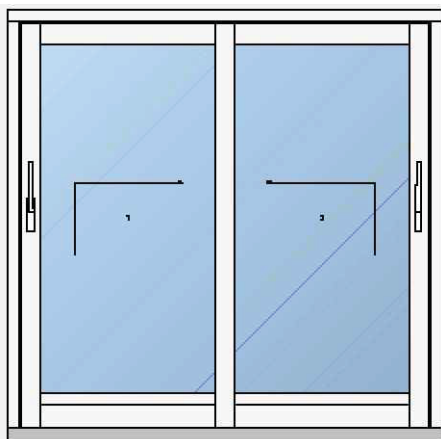

Schemat D (2 kw.) skrzydło lewe wewn., prawe zewn.

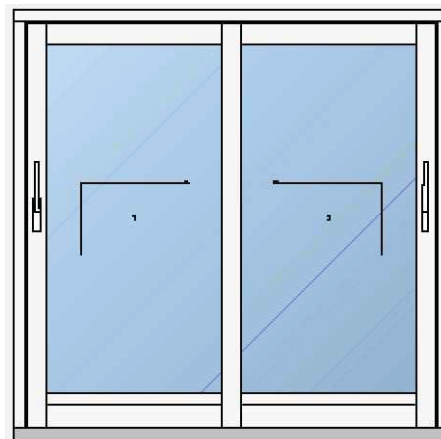

Schemat D (2 kw.) skrzydło lewe zewn., prawe wewn.

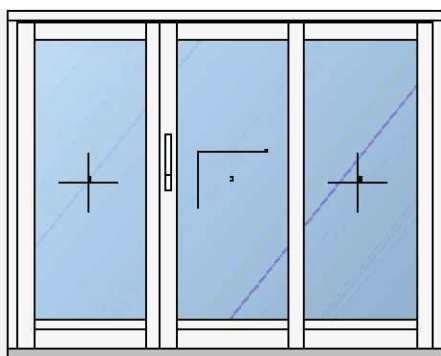

Schemat G2 (3 kw.) otw. na prawo

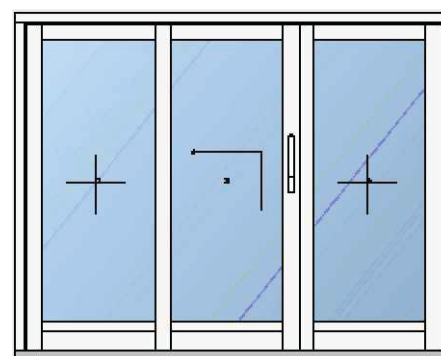

Schemat G2 (3 kw.) otw. na lewo

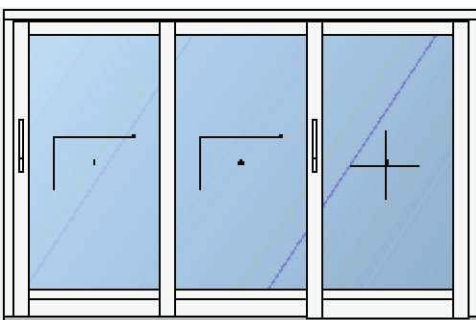

Schemat E (3 kw.) otw. na prawo

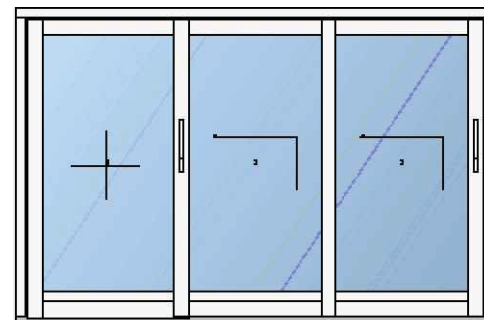

Schemat E (3 kw.) otw. na lewo

Drzwi podnosząco - przesuwne HST

Schematy HST do wykonania

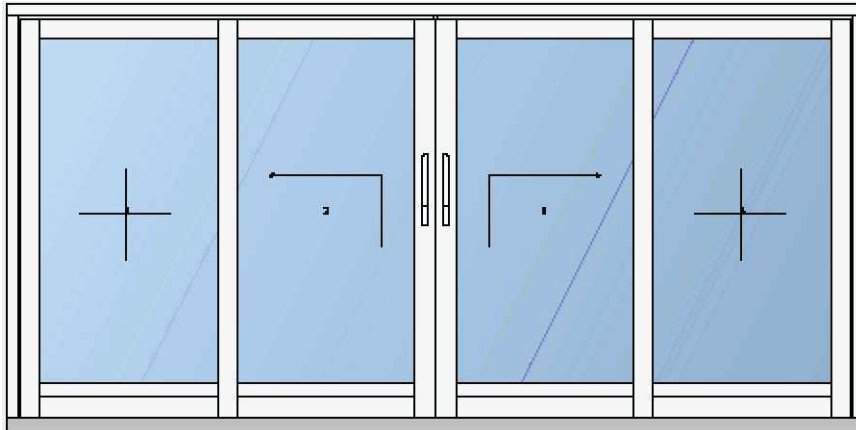

Schemat C (4 kw.) otw. na prawo

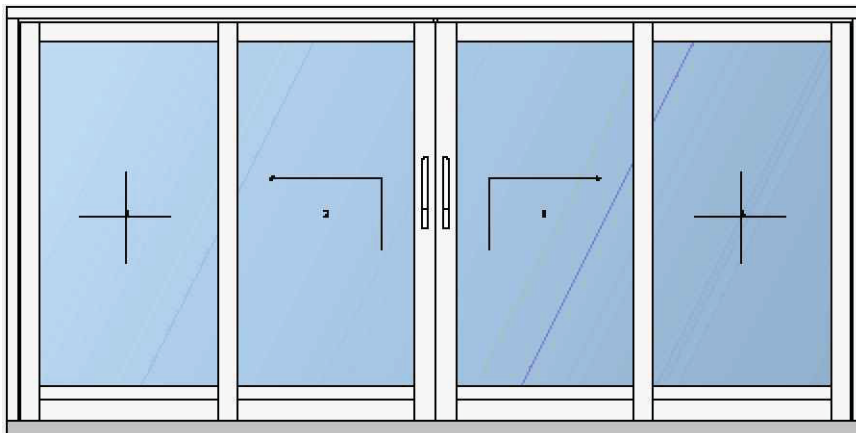

Schemat C (4 kw.) otw. na lewo

Drzwi podnosząco - przesuwne HST
Przekrój przez próg aluminiowy THERMOSTEP

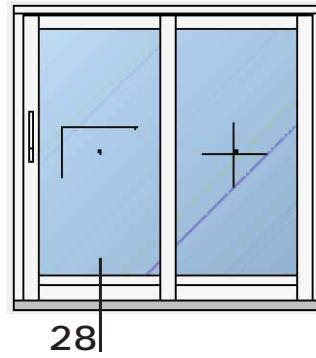

28-28 v.1

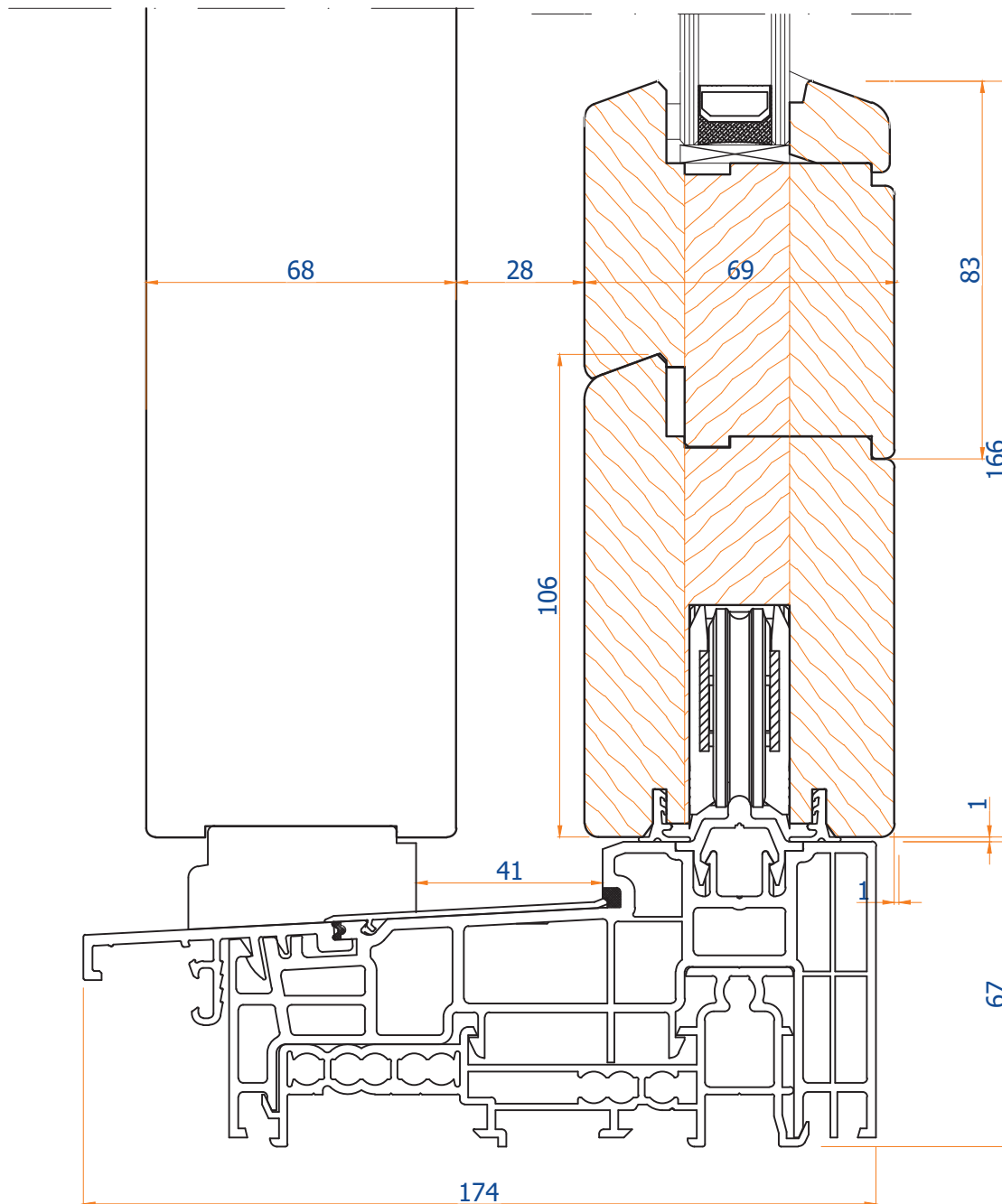

PRÓG HS G-U THERMOSTEP

Drzwi podnosząco - przesuwne HST
Przekrój przez próg aluminiowy FLATSTEP

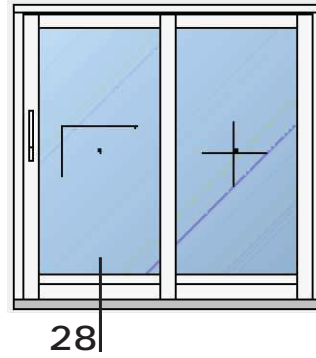

28-28 v.2

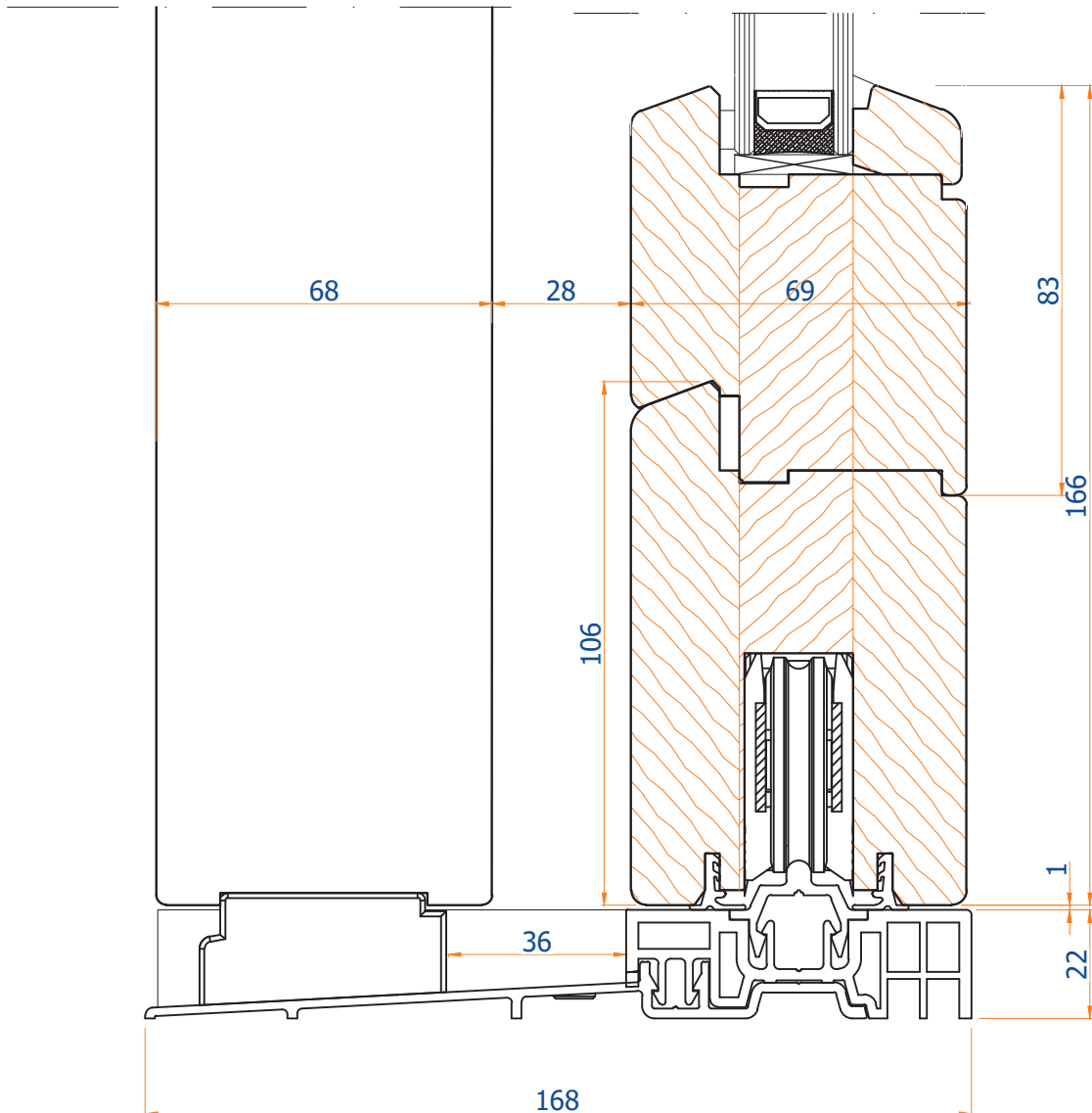

**Tylko do schematów
A,C,D,G2**

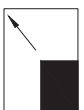

1:1,5

Drzwi podnoszone - przesuwne HST

Przekrój przez belkę górną część przesuwna

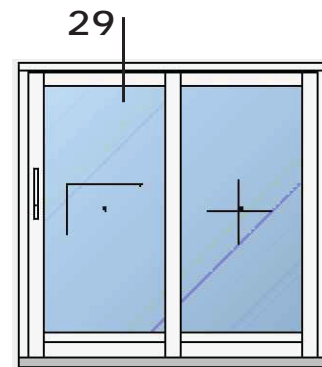

29-29

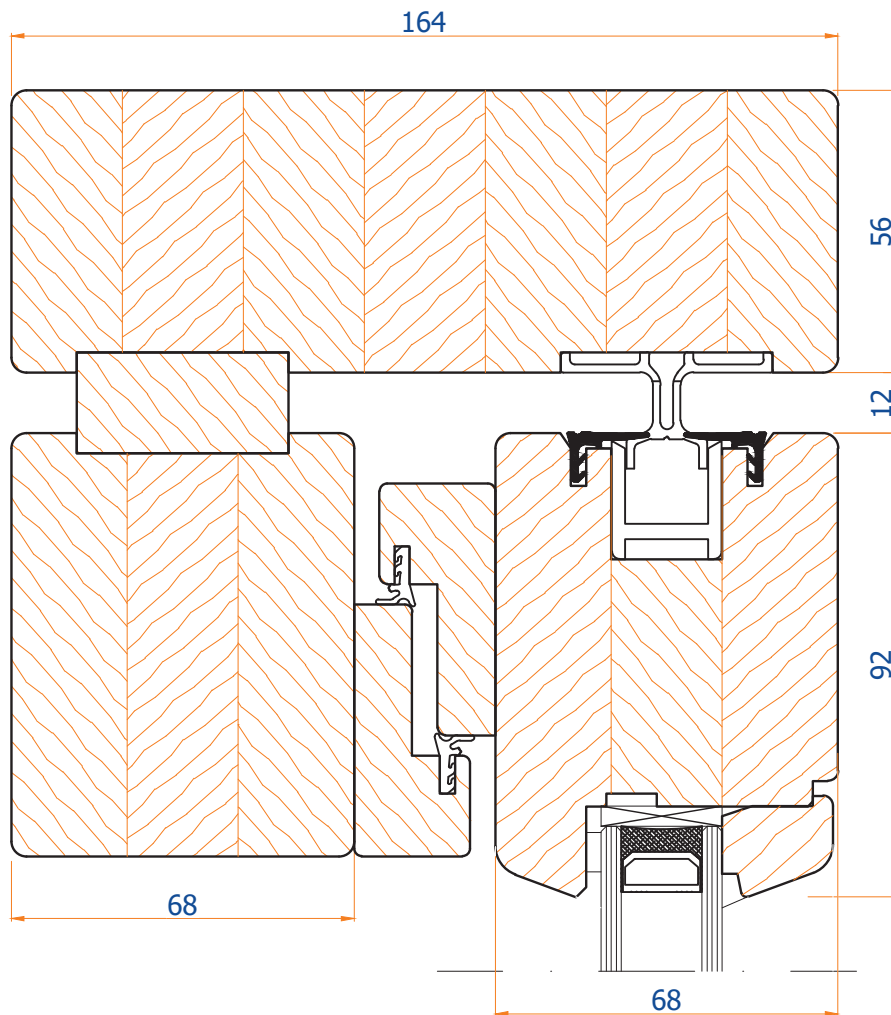

1:1,5

Drzwi podnosząco - przesuwne HST

Przekrój przez belkę górną część stała

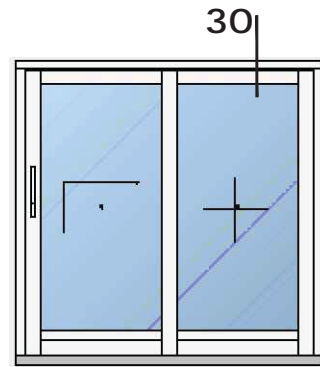

30-30

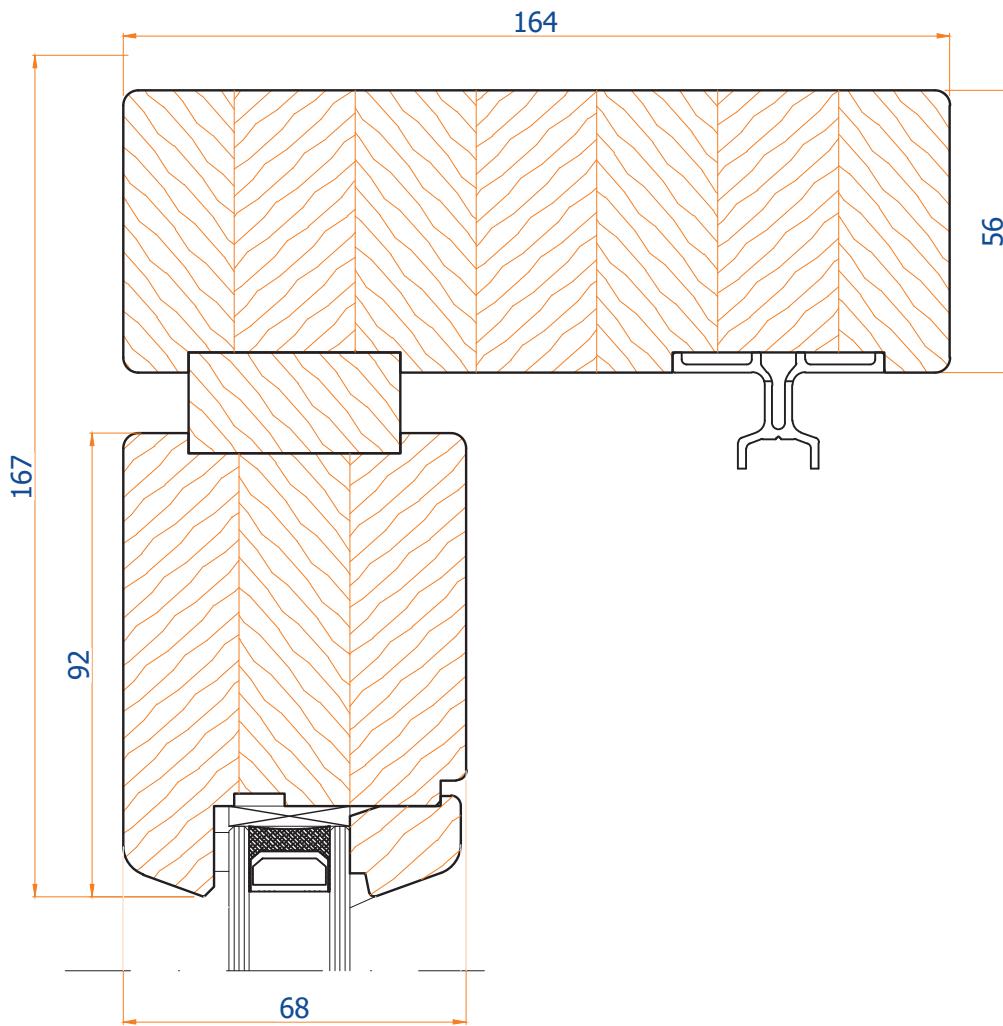

1:1,5

Drzwi podnosząco - przesuwne HST

Przekrój przez belkę z klamką

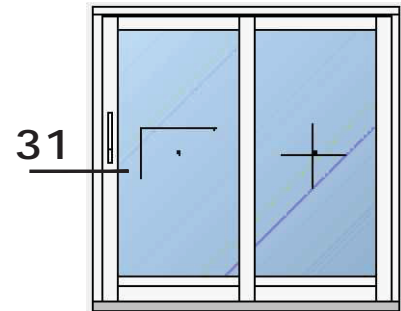

31-31

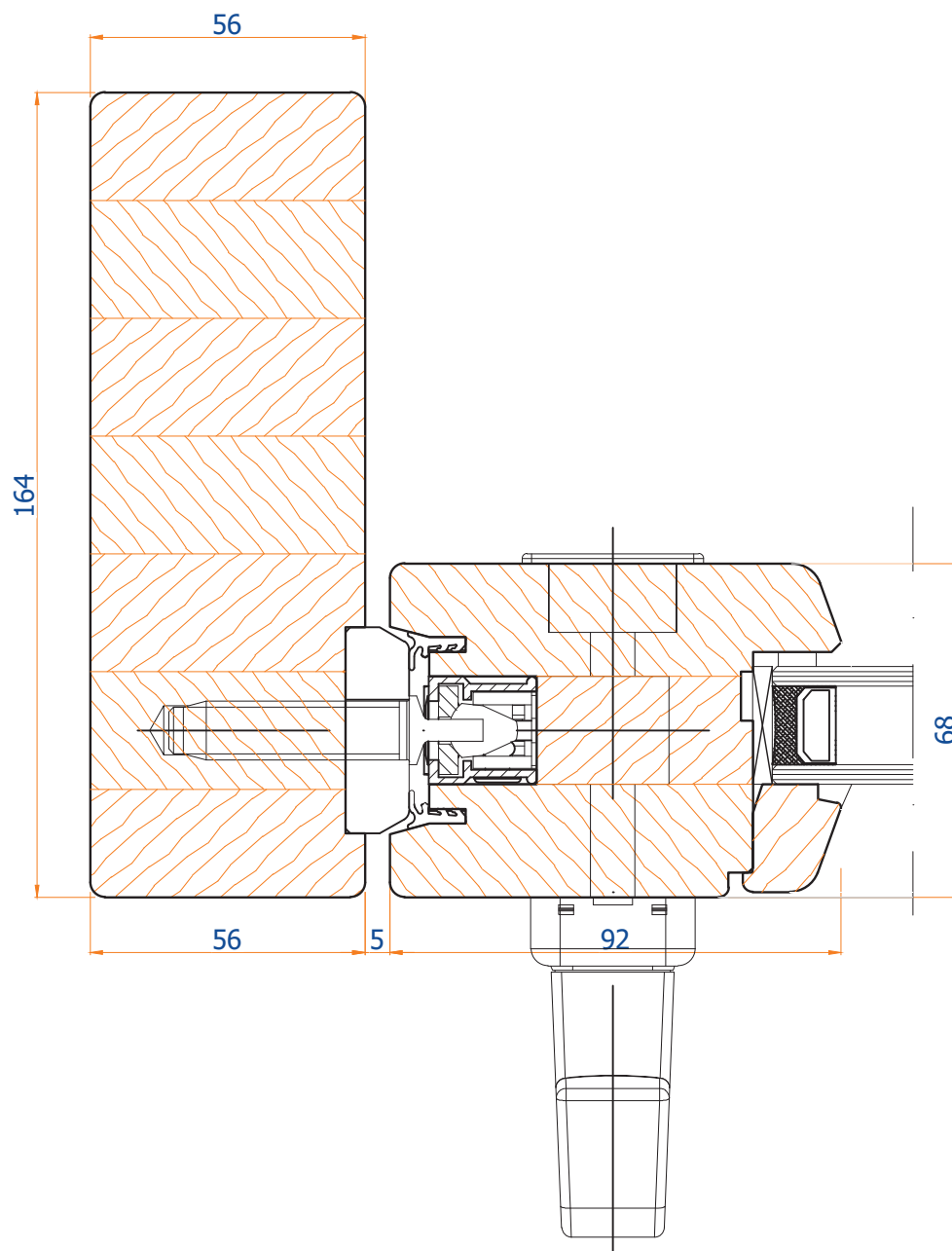

1:1,5

Drzwi podnosząco - przesuwne HST

Przekrój przez łączenie skrzydeł

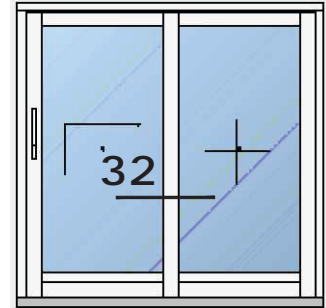

32-32

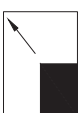
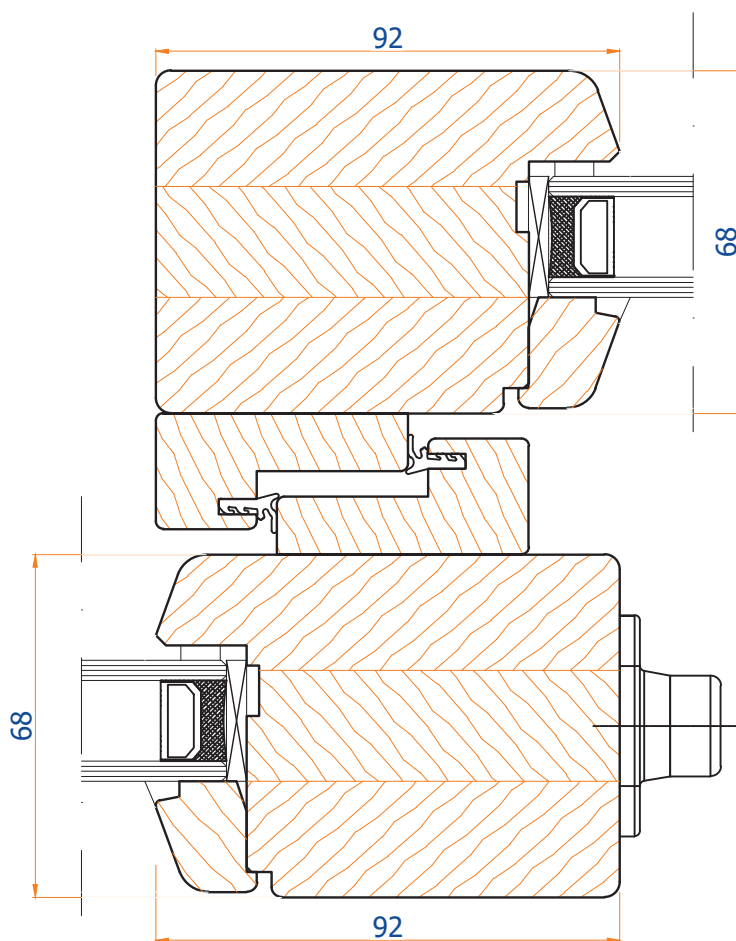

1:1,5

Drzwi podnosząco - przesuwne HST

Przekrój przez belkę boczną część stała

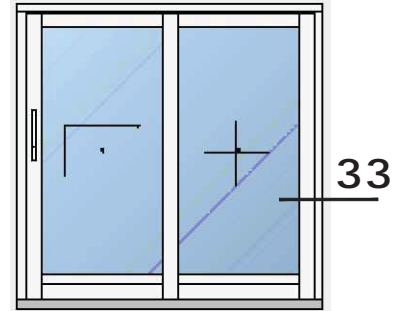

33-33

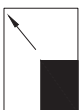
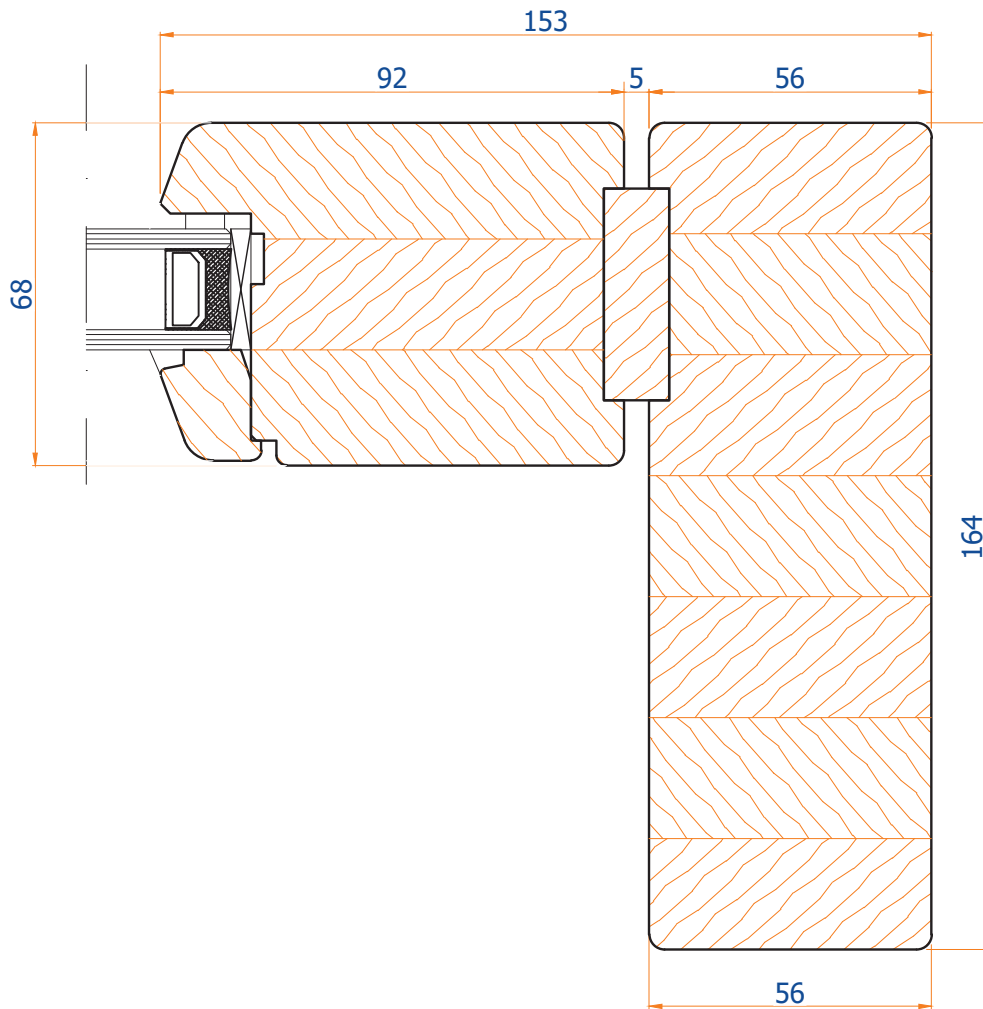

1:1,5

Drzwi podnosząco - przesuwne HST

Przekrój przez próg aluminiowy THERMOSTEP

34-34

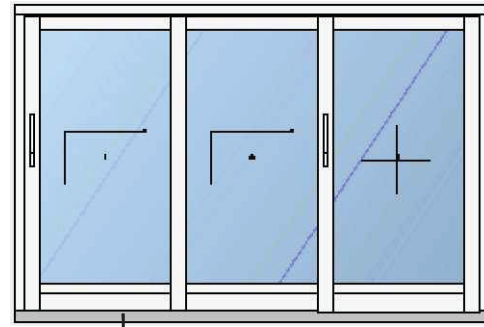

34 |

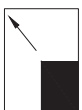
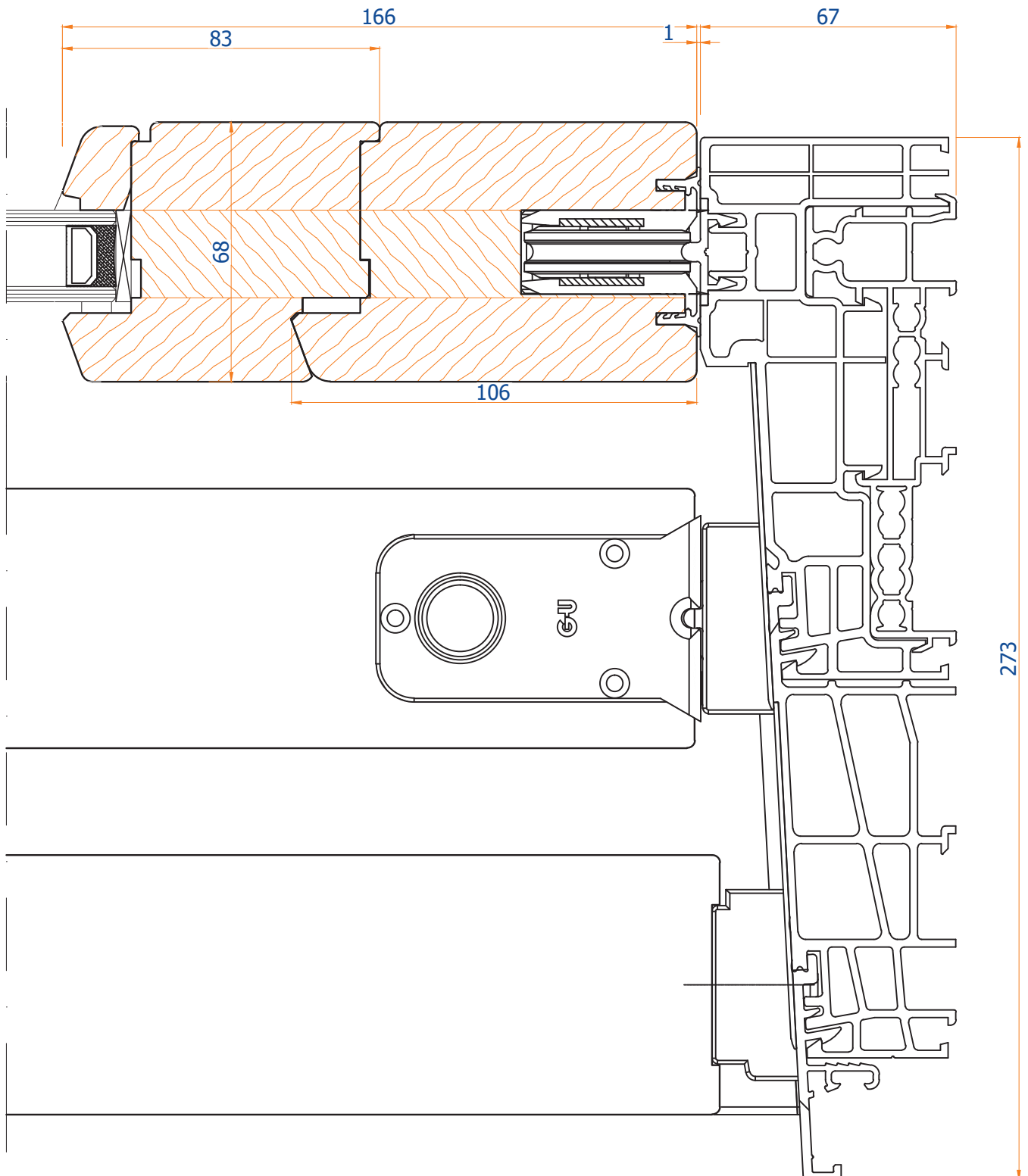

1:1,5

Drzwi podnosząco - przesuwne HST

Przekrój przez ramę góra

35-35

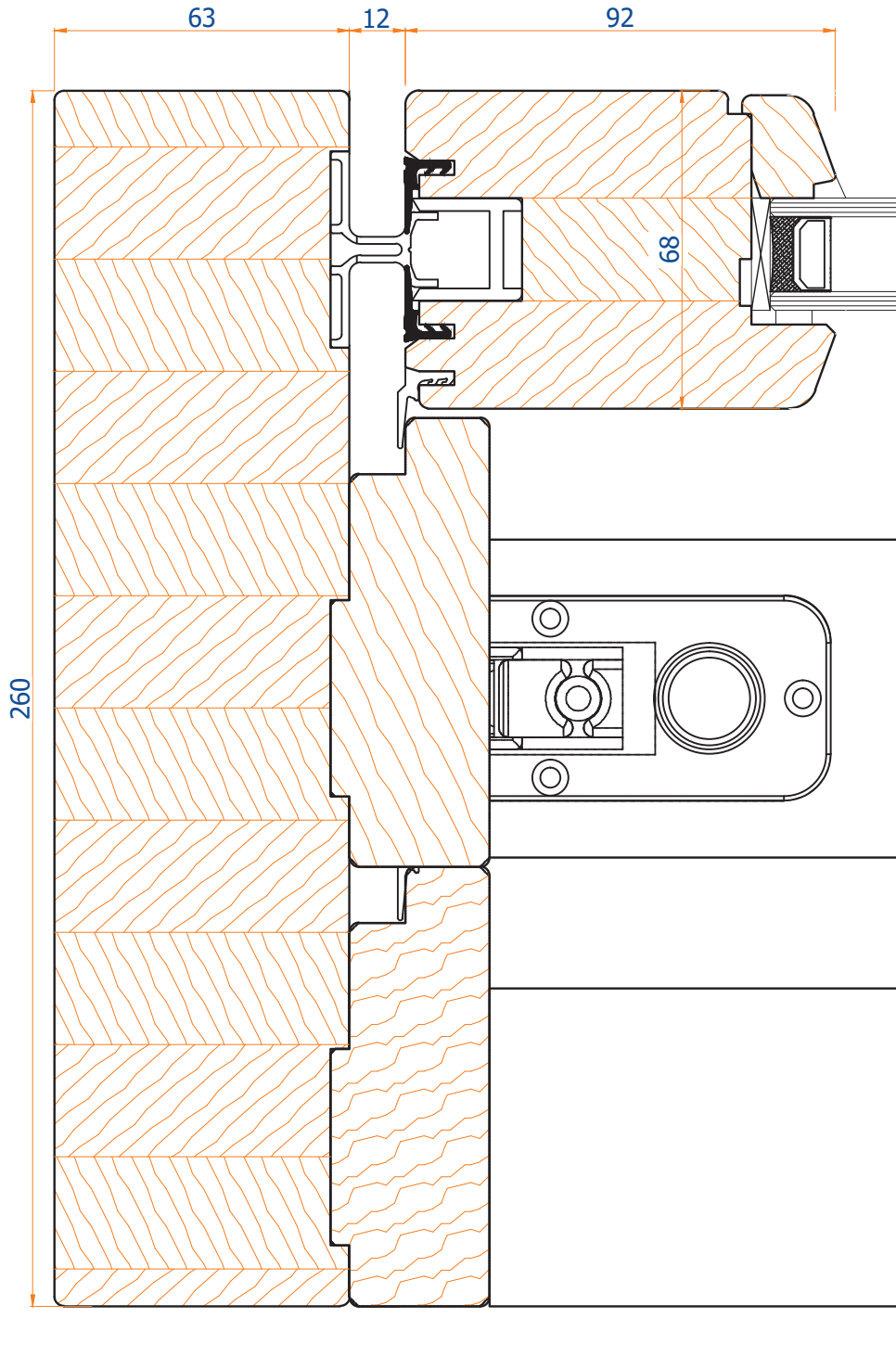
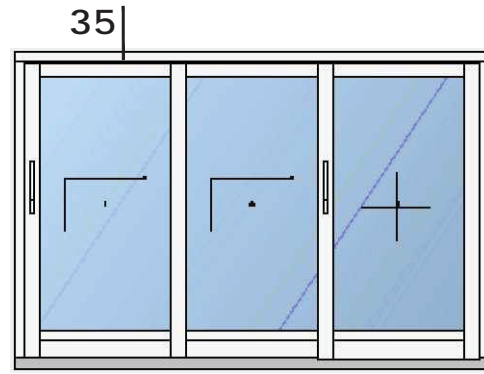

1:1,5

Drzwi podnoszone - przesuwne HST

Przekrój przez ramę góra

36-36

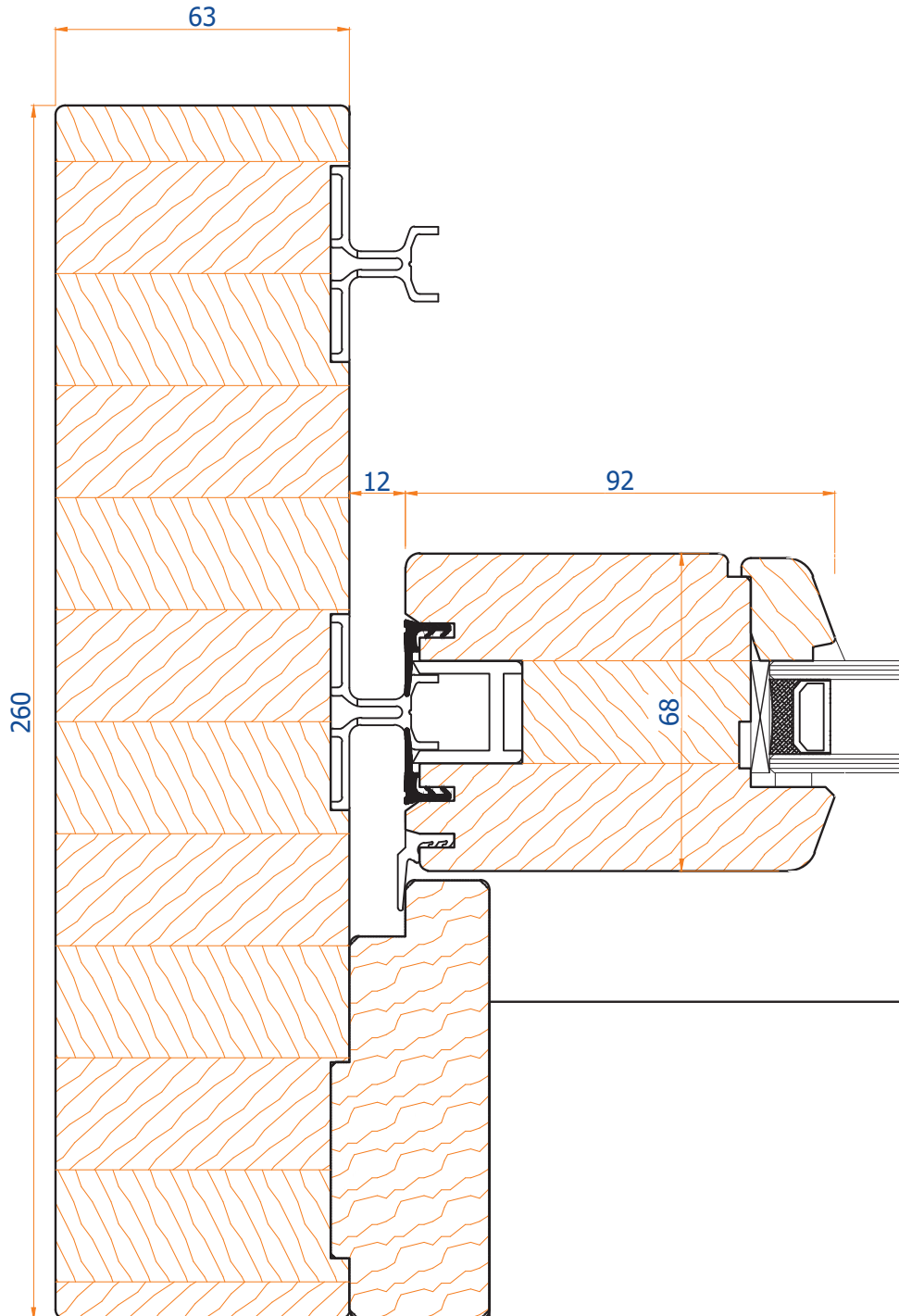
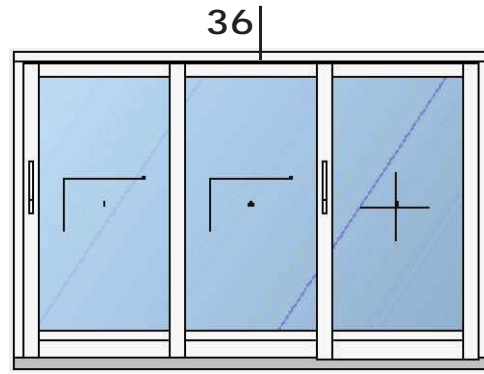

1:1,5

Drzwi podnosząco - przesuwne HST

Przekrój przez ramę góra

37-37

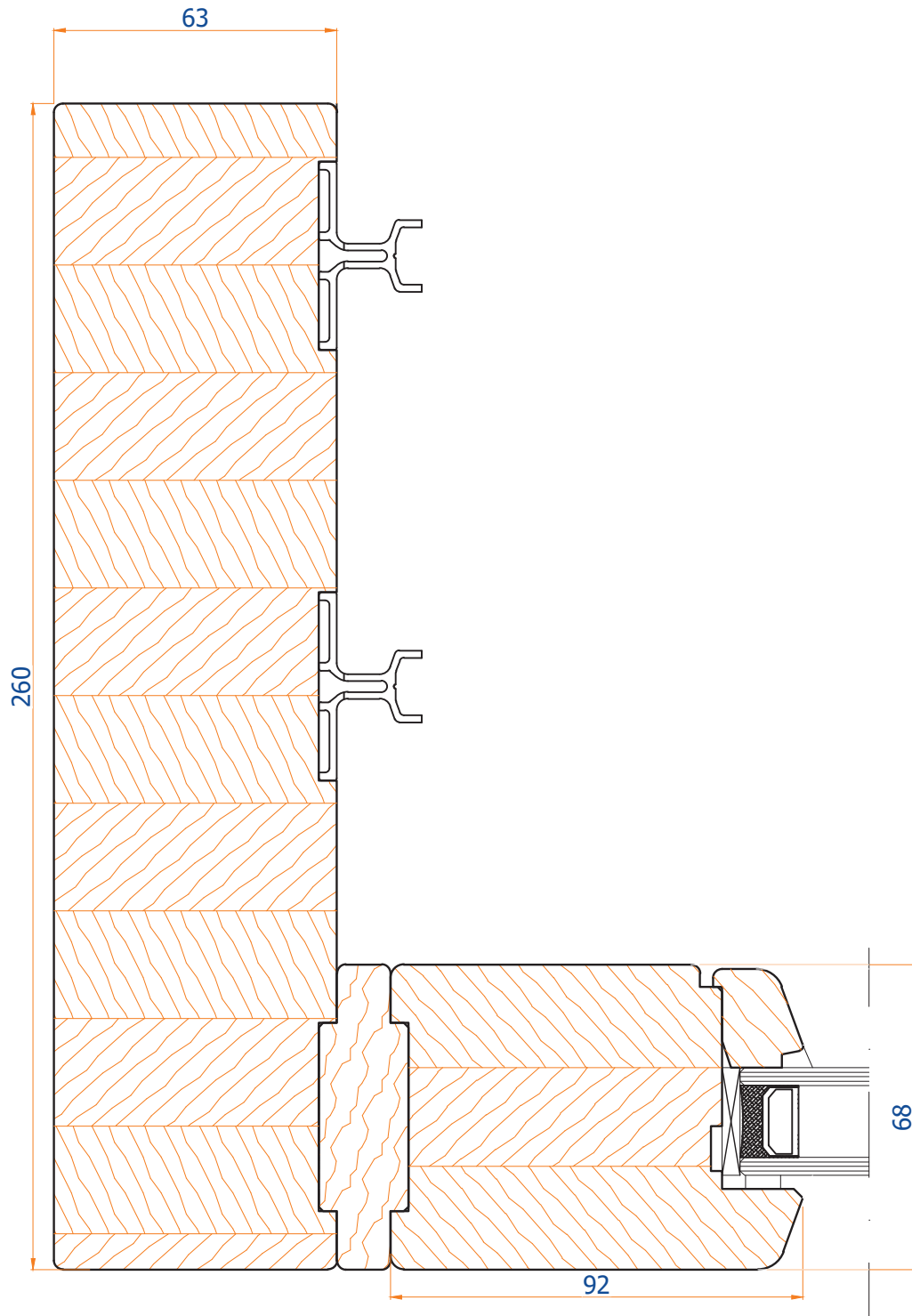
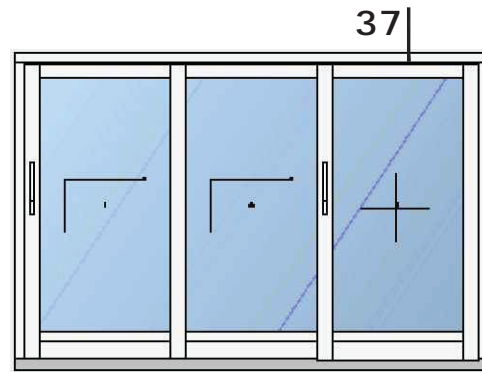

1:1,5

Drzwi podnoszono - przesuwne HST

Przekrój poziomy "Schemat E"

38-38

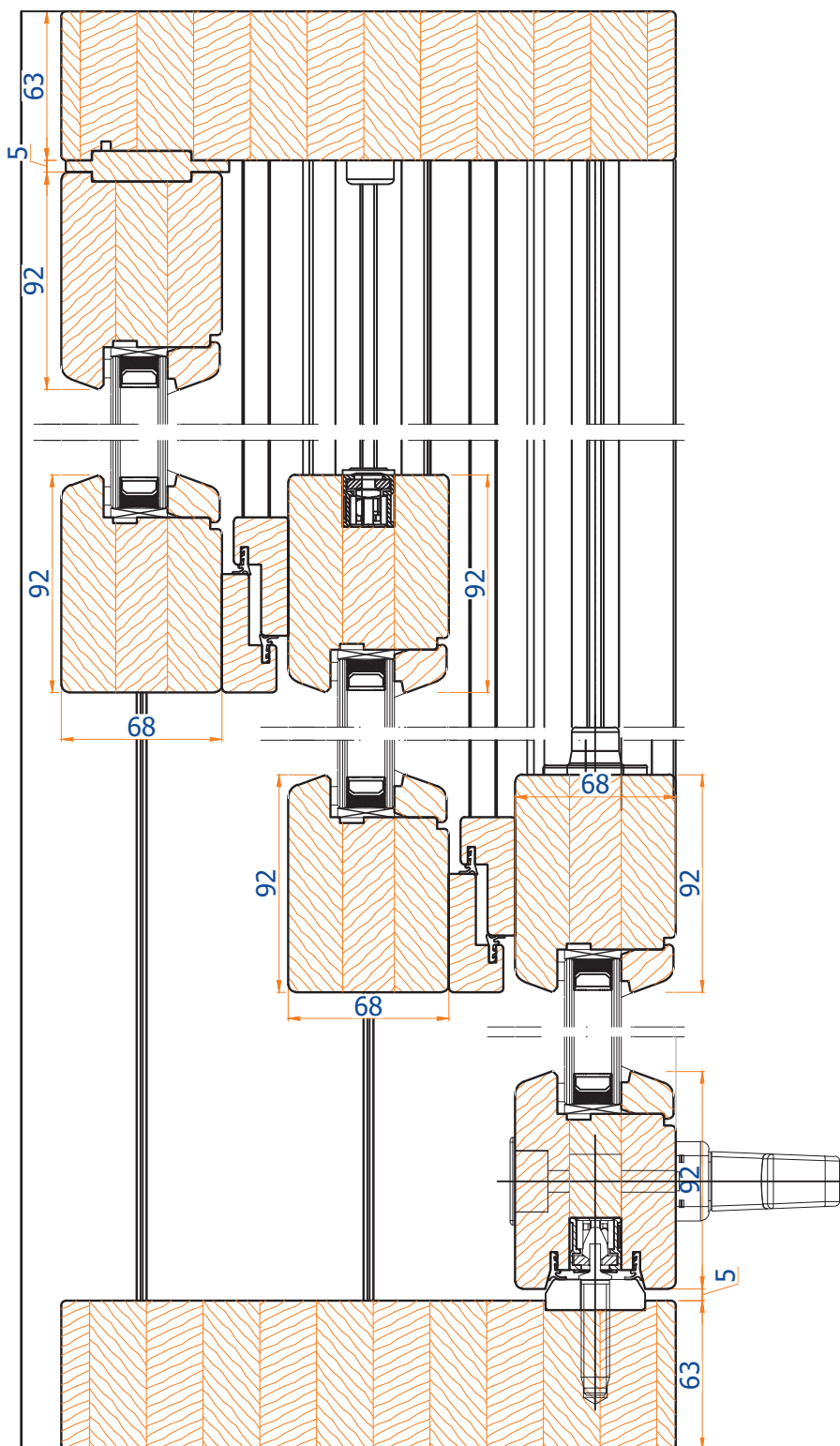
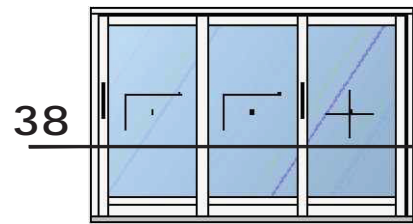

1:3